

The ECE Current

ELECTRICAL AND COMPUTER ENGINEERING DEPARTMENT, UC SANTA BARBARA

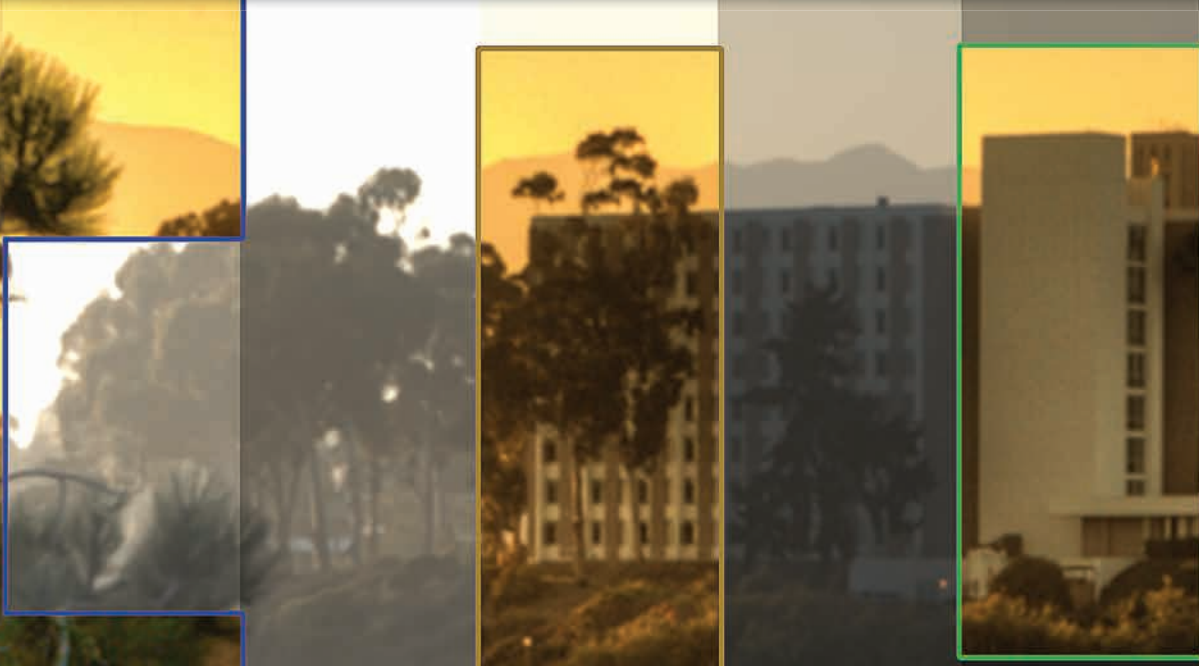

Capturing high-quality HDR images
see page 7 for details

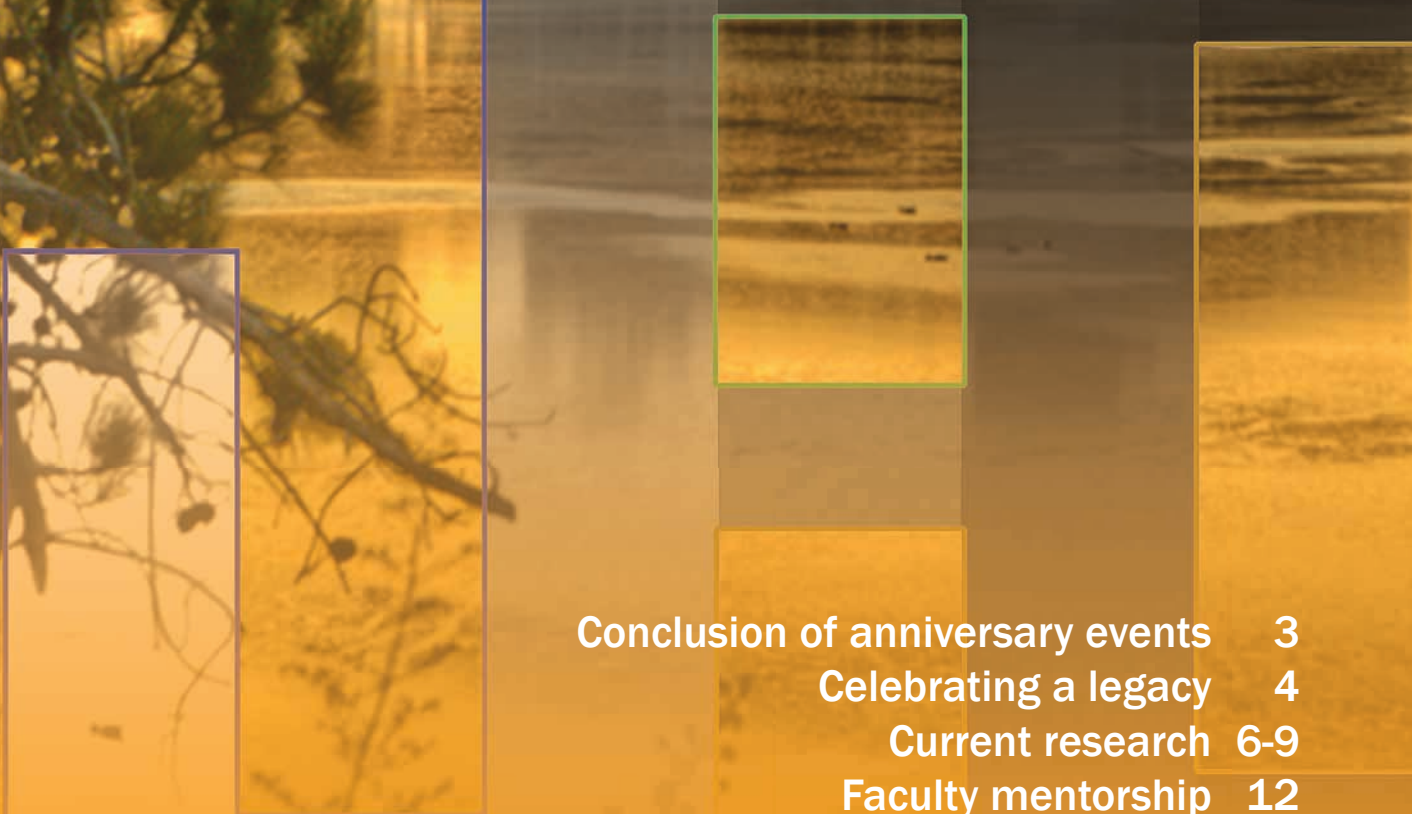

Conclusion of anniversary events	3
Celebrating a legacy	4
Current research	6-9
Faculty mentorship	12

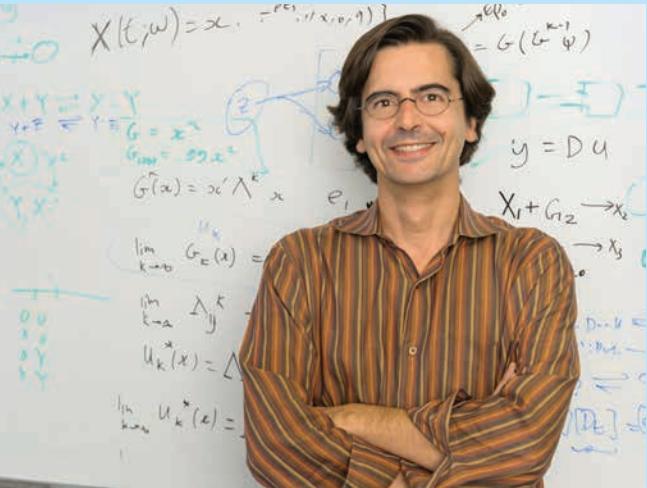

In this first ECE newsletter coming out since my appointment as Chair of the Department, I would like to thank the previous chairs, the rest of our faculty and staff, and our students for their strong commitment and hard work, which has made ours a top department in the country.

In spite of the recent state budget reductions, Jerry Gibson left the Department in a solid financial situation and was even able to organize several high-profile events to commemorate the Department's 50th anniversary. In this regard, I should also acknowledge the support of our Dean and of the UCSB administration in shielding the departments from larger financial blows. The ECE faculty continues to excel in teaching and research, and in this issue of "The Current" you will see a glimpse of what they have been up to. As Chair, one of my key priorities will be to make sure that the faculty accomplishments get the visibility and recognition that they deserve. Another key priority will be to make sure that we continue to hire the best faculty available. As you will see in this issue, our recent faculty

hires have been exceptional, and I am committed to making sure that the two ongoing searches will also result in outstanding additions to our faculty. I also want to recognize the essential role that our staff plays in the daily operation of the Department. My role as Department Chair (and previously as Vice-Chair) is enormously simplified by the support of the hard working, reliable, and generous staff. Because UCSB's staff has been tremendously affected by the recent budget cuts, it is crucial to make sure they are shielded from further damage.

On the academic front, we must continue to update and improve our undergraduate and graduate programs. Revising an electrical engineering curriculum feels like painting the Golden Gate Bridge: when you finish on one end, you must immediately restart at the other end. This is a joint effort of the whole faculty that involves careful consideration and difficult tradeoffs, and is guided by the principle that we want our graduates to succeed in an environment dominated by constant technological changes. Feedback from external reviewing agencies and from our alumni is crucial towards achieving this goal.

Last in this letter, but at the top of our priority list at UCSB, come our students. I am pleased to report that the Department continues to be driven by absolutely top students. In the last season, we had more applicants to our graduate program than any other department at UCSB (by almost a factor of two) and our admission rate for the Fall '13 class was below 20%. We are eager to welcome the new students and to help them navigate through their degrees.

João Pedro Hespanha
João P. Hespanha, Department Chair

Professor Jon Schuller Receives AFOSR Award Honor



Professor Schuller received the Air Force Office of Scientific Research (AFOSR) Young Investigator Award for his work in Infrared Semiconductor Metamaterials. One of 40 scientists and engineers who will receive

approximately \$15 million in grants from the AFOSR-YIP. The objective of this program is to foster creative basic research in science and engineering, enhance early career development of outstanding young investigators, and increase opportunities for the young investigators to recognize the Air Force mission and the related challenges in science and engineering.

Professor John Bowers Receives UCSB Faculty's Top Honor

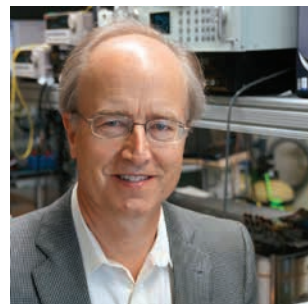

Professor Bowers has been named Faculty Research Lecturer for 2013. The award is the highest bestowed by the university on one of its faculty, and Bowers is being recognized for his "groundbreaking scholarship, outstanding research contributions and

scientific leadership."

"I'm very thrilled and honored to receive it," said Bowers. "Obviously, having your peers select you for the award is phenomenal and very appreciated." Bowers is the 58th recipient of the Faculty Research Lectureship since the award's creation in 1955.

50 Years of Excellence



This spring ECE wrapped up a yearlong 50th Anniversary celebration with two final talks in the 50th Anniversary Distinguished Lecture series. The first of these was presented on March 14th by Wei-Ying Ma, Assistant Managing Director, Microsoft Research Asia. In his talk, “The Next Frontier for Web Search and Knowledge Mining: My Journey since Alexandria Digital Library Project at UCSB”, he shared his journey from UCSB to now and what might be ahead for next-generation web search with a new mission to empower people with knowledge. The fourth and final lecture of the series was held on Friday, April 26th by InTouch Health Chairman and CEO Yulun Wang. His lecture, “New Healthcare Delivery Models using Remote Presence and Telemedicine”, showcased how telemedicine is raising the quality and accessibility while reducing the costs of healthcare across the world through remote presence

Wei-Ying Ma and Yulun Wang presenting lectures as part of ECE’s 50th Anniversary Distinguished Lecture Series.

robotics. Yulun touched on healthcare challenges that we face today and how technology advances in healthcare informatics, remote diagnostic and therapeutic tools, telecommunications, and robotics can lessen them.

To see videos of the talks, visit: ece.ucsb.edu/anniversary

Professor Ron Iltis Retires



After 29 years with UCSB, Professor Ron Iltis has retired from teaching in the ECE Department, though he will continue his research program as a Research Professor. His service to the Department, College, and the campus include EE Director of the College of Engineering ABET committee, Department Vice-Chair for Graduate Administration, and a member

of the UCSB Faculty Legislature. He joined the Department in 1984 soon after graduating from UC San Diego, with previous industrial experience at General Dynamics and Linkabit.

Professor Iltis contributed significantly to course development by introducing a key graduate course on stochastic processes and significantly revising undergraduate courses on filter design, signal processing, and probability. He was a recipient of the Outstanding Faculty Member award for teaching that is given each year by the Engineering Student Council, and several of his PhD graduates hold tenured faculty positions.

Professor Iltis’ research focuses on wireless networks and channel estimation for underwater acoustic and terrestrial radio frequencies. He was an original proponent for finding practical solutions to the problem of jointly estimating time-of-arrival and channel parameters for multiple users in quasi-synchronous CDMA networks. Professor Iltis also provided fundamental contributions to solving the data fusion problem in multi-target tracking. His work on the applications of nonlinear estimation to digital communications was recognized with the Fred W. Eilersick Best Paper award at the IEEE MILCOM conference.

Professor Umesh Mishra Named Whittier Chair



Professor Umesh Mishra was named the Donald W. Whittier Chair in Electrical Engineering. The Donald W. Whittier Chair is an endowment

established to support the teaching and research activities of a distinguished faculty member within UCSB’s College of Engineering. Donald W. Whittier founded the Mericos Foundation, a charitable foundation based in South Pasadena that supports various philanthropic activities in the Southern California area. Mr. Whittier actively supported philanthropic projects in Santa Barbara until his death in 1983.

Professor Mishra joined the ECE department in 1990. A recognized leader in the area of high-speed field effect transistors, Professor Mishra has made major contributions at every laboratory and academic institution for which he has worked. His current research areas attempt to develop an understanding of novel materials and extend them into applications.

Herb Kroemer Symposium

MAY 20, 2013

On May 20, 2013 a major invitation-only symposium was held on the UCSB campus in honor of Dr. Herbert Kroemer, Professor of Electrical & Computer Engineering and Materials, Nobel Laureate in Physics in 2000, and a major contributor to the solid-state sciences for several decades. The symposium was a celebration of Professor Kroemer's many career and scientific achievements. An impressive list of more than twenty international leaders in semiconductor device physics gave invited presentations following welcoming remarks from Dean Alferness and Chancellor Yang. Program details, slides, and photos are available at <http://engineering.ucsb.edu/kroemer-symposium/>

Following the presentations at the Symposium, there was a light reception, and then Chancellor Yang hosted a dinner at University House for the invited speakers and a few other special guests.

The Symposium program included presentations from some of Prof. Kroemer's former colleagues as well as others who were otherwise strongly influenced by him. The first speaker, Prof. Hans-Joachim Queisser, a founding director of the Max-Planck-Institute at Stuttgart, also well known for his early work on solar cells, spoke fondly of interactions with Prof. Kroemer over many years. Prof. Peter Asbeck of UC San Diego then continued with a summary of some of Prof. Kroemer's technical contributions to heterojunctions as well as his most effective teaching methods. Prof. Eli Yablonovitch of UC Berkeley recounted how Prof. Kroemer had made a tremendous first impression on him. Prof. James Harris of Stanford talked of their early interactions, emphasizing Kroemer's well-known insistence on understanding the device bandstructure and introducing his contributions to lasers. Then former UCSB colleague Prof. James Merz, now emeriti Prof. of Notre Dame, discussed

how Prof. Kroemer and he built the world-class compound semiconductor program at UCSB, partially by raiding Bell Laboratories. UCSB Prof Art Gossard, and former Bell Labs raidee, followed by recounting how the famous UCSB molecular-beam-epitaxy (MBE) lab was expanded, together with Prof. Kroemer. Dr. Bobby Brar, a former student of Prof.



Kroemer and now President of Teledyne Scientific, recounted how the pioneering HBT work during his time included efforts on many III-V materials with various band lineups. The first session ended with presentations by Profs. Lars Samuelson of Lund Univ. and Pierre Petroff of UCSB, who both mentioned novel nano-structures investigated together with Prof. Kroemer.

Following some opening remarks by UCSB Prof. Larry Coldren, who chaired the organizing committee for the Symposium, the second session opened with a stimulating talk by Prof. Jerry Woodall of UC Davis, known for growing the first high-quality heterostructures and a recipient of the National Medal of Technology. Former UCSB Prof. Evelyn Hu, now at Harvard, then discussed interfaces: hetero- and collegial—recalling some of her early days at UCSB and the significant interactions with Prof. Kroemer. Dr. Seshadri Subbanna, a former student of Kroemer's and now an IBM executive, reviewed both Prof. Kroemer's continuing influence in teaching as well as in Si-Ge IC technology. Prof. Klaus Ploog, an early pioneer in MBE and a Director at the Paul Drude Institute, highlighted some of the many lifetime contributions of Prof. Kroemer to solid-state electronics. Prof. Venky Narayanamurti, former Dean of Engineering at UCSB, then at Harvard, emphasized how Prof. Kroemer's pioneering scientific work, like that of some other Nobel Laureates, led to important technological advances. Prof. Jorg Kotthaus of Ludwig-Maximilians-University (LMU) in Munich praised Prof. Kroemer for contributing so strongly to a joint UCSB-LMU collaboration on semiconductor nanostructures that has lasted over two decades. Two of Prof. Kroemer's students followed, praising him as an unusually strong and model Professor and Mentor—Dr. Chanh Nguyen, a manager at Teledyne Scientific, and Prof. William Frensley of UT Dallas. The second session closed with short presentations by four of Kroemer's UCSB colleagues—Profs. Rodwell, Mishra, Palmstrom, and Bowers—who each uniquely recounted Prof. Kroemer's strong influence in their research and careers.

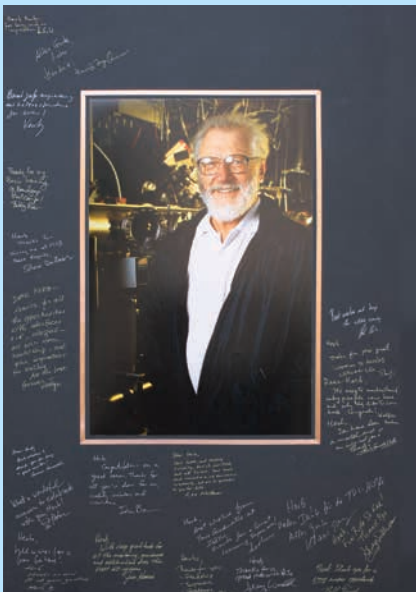

Alumni Spotlight

J E F F B L O K K E R

Jeff Blokker completed PhD course work in Electrical Engineering and was a research assistant under Nobel Laureate Herbert Kroemer investigating GaAs device fabrication at UCSB. He left school with a Masters degree in 1984 to form a corporation, CableSoft Inc, that he ran as CEO for 18 years. He has a broad engineering background with expertise in material, software development, networks including wireless and advanced computing. In 2010 he completed a Masters degree in Financial Mathematics at Stanford University.



Q: What do you think UCSB's engineering program strengths are – particularly in electrical engineering?

A: There's more growth here than I've seen anywhere else. I think the power and the quality of the research at UCSB and the professors at UCSB are more concentrated, meaning they do more with a lot less resources. There's more vitality in the research in the engineering department at UCSB than I've seen in any other place.

Q: What do you think of research opportunities for undergraduates and graduate students?

A: At UCSB you can get connected to the top researchers. You can specialize and get a really in-depth experience in the field that you're interested in. You may even try others that you didn't realize you were interested in and go in an entirely different direction. I think the diversity of this school really makes it stronger than other universities.

Q: Tell us more about your time spent with Herb Kroemer as a graduate mentor before he was awarded the Nobel Prize.

A: Herb Kroemer was really the teacher you had to impress if you wanted to go on. His classes were notoriously tough but also notoriously thorough. I learned a lot of things from him: to take pride in your work, to work hard and the quality of work. It was really his leadership that set a standard for the entire device fabrication department and it took the engineering school where it was to where it is today.

Q: Do you have any advice to entrepreneurial students who are going to be graduating soon?

A: You need to figure out what the market is and how the market works rather than just going out and developing an engineering idea. You also need to talk to people who have been in business to see whether or not your idea will flourish. The Technology Management Program (TMP) has a business plan competition. It has actually spawned new businesses and allowed these young entrepreneurs to gather feedback about their business plans.

Q: You and your family have generously given back to UCSB Engineering over the past 20 years. What motivates your investment in your alma mater?

A: We're actually very proud to speak of everything that we've done. The money has been spent in various different places around Santa Barbara, California, and the world. I would encourage ECE alumni to come back if they have the opportunity and find something that interests them and spend the time to make a simple donation because it will pay back beyond what you can imagine.

Q: Any advice to your fellow Engineering Alumni in getting involved with the College of Engineering?

A: I would suggest going back and figuring out what you're interested in and exploring it at the University with the professors. There may be opportunities there for alumni to contribute and it could be contribution by money, time, effort, or in any way that makes you feel good, but I definitely think that the time and money spent here is a good investment.

Q: Any advice to new freshmen who might be looking to make the most out of their career but are just starting off?

A: Don't be afraid that you don't know what you want to do. If you don't know what you want to do, explore all the different avenues that you might imagine you want to do. College is the time to find yourself and there are so many doors here at UCSB, you should open as many as you can and don't waste the time because typically, your college years are the best years of your life.

To see a video of this interview, visit: ece.ucsb.edu/profiles/Blokker

Research Initiatives...



Nanometer Transistors and III-V CMOS

Professor Mark Rodwell



Even as transistors approach their physical limits, aggressive research can still greatly improve the transistors used by wireless systems and by computers and VLSI. Mark Rodwell, Doluca Family Endowed Professor in Electrical and Computer Engineering, and his research group work to extend transistors in VLSI to the smallest possible dimensions, and work to extend the operation of electronics to the highest feasible frequencies.

Closely collaborating with their long-term partners at Teledyne Scientific, Rodwell's group is working to push the operating frequencies of InP heterojunction bipolar transistors (HBTs) beyond established microwave and millimeter-wave frequencies and well into the infrared. At present the best transistors from Teledyne and from UCSB have cutoff frequencies around 1.0-1.2 Terahertz (THz, a trillion cycles per second). With these, the two teams have together recently demonstrated many record-setting integrated circuits for wireless transmitters and receivers, with chips at 94GHz, 220GHz, 340GHz, and even as high as 670GHz. These ICs make available vast amounts of spectrum for new generations of wireless communications. Similar chips in Teledyne's THz IC technology, being developed jointly by Rodwell's, Coldren's, and Bowers' groups, will in the future capture a full THz of signal spectrum from an optical fiber, replacing a large array of wavelength-multiplexed optical receivers with a single electrical and a single optical IC. To push signal frequencies yet higher, to around 1-2 THz, UCSB and Teledyne work to push the transistor cutoff frequencies to 2-3 THz, an effort presenting enormous challenges in advanced materials and in fabrication at few-nanometer critical dimensions.

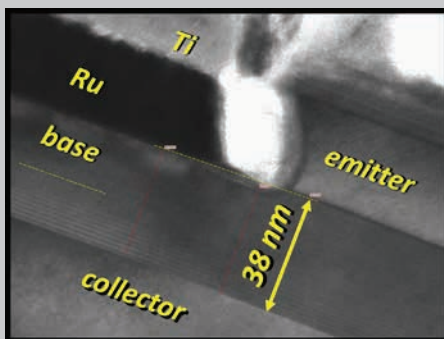

Collaborating with Professor Stemmer's and Gossard's groups at UCSB, McIntyre's at Stanford and Kummel's at UCSD, Rodwell's group also is developing nanometer transistors for the next few generations of VLSI, focusing on MOSFETs using the III-V compound semiconductors as the channel materials, these being at the core of UCSB's expertise. Recent transistors show extremely high on-currents needed for high-speed operation, with as much 2.7 milliSiemens transconductance per micron of gate width. They have developed new finFETs, formed using single-atom-precision growth techniques, which should work well even at below 8 nanometer gate lengths, yet switch at high speed, and very low operating voltage (as little as 300mV) and very low switching energy.

To learn more, visit: ece.ucsb.edu/Faculty/Rodwell

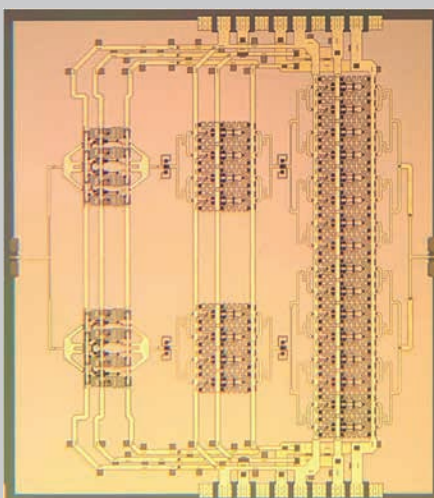
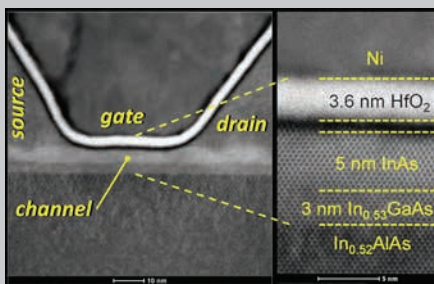

Did you know?

The UCSB Nanofabrication Facility...

- Consists of over 10,000ft² of class 100/1000 cleanroom space, having grown from ~1,000ft² in the past twenty years, and includes more than 60 semiconductor process tools.
- Has over 1200 registered users. Most days thirty to forty different people utilize the lab and in any yearly quarter between 300 to 400 different researchers enter the lab.
- Is one of the most heavily used labs on campus with about 6000 total hours of lab time logged each month in the Nanofab by the various academic and industrial users as recorded by iris scanners at the lab entrance and exit.
- Jack Whaley managed the facility from 1989 until his retirement in August 2013. Tom Reynolds is now the manager of the facility with Mark Rodwell as Director.

The Nanofab staff are: Adam Abrahamsen, Tony Bosch, Mike Day, Don Freeborn, Claudia Gutierrez, Aidan Hopkins, Brian Lingg, Tom Reynolds, Mike Silva, Tino Sy, Luis Zuzunaga, and staff scientists Ning Cao, Bill Mitchell, Biljana Stamenic, and Brian Thibeault.

High Dynamic Range (HDR) Imaging with Commodity Cameras

Professor Pradeep Sen

The world around us has a variation of light intensity that can range from very bright to the very dark. While our eyes are able to see this large range of illumination simultaneously (for example, we can see a person in a dark room standing in front of a bright window), standard digital cameras can only capture a limited range of the light intensity in a scene. These low dynamic range (LDR) imagers produce images that do not resemble what we see with our own eyes, making high-quality photography challenging for non-professionals.

ECE Associate Professor Pradeep Sen and his team of students are working on automated algorithms that will produce high-quality, high dynamic range (HDR) imagery directly from the LDR images taken with a standard consumer camera. To do this, they exploit the fact that these cameras can take a rapid sequence of images at different exposures, some capturing the detail in the dark regions and others the detail in the bright regions. These images are then merged together to produce HDR images that contain detail at all illumination levels simultaneously. The key challenge is handling moving objects or camera motion, and for this Prof. Sen and his team have developed a patch-based synthesis method to register the images together during the merge process. This allows them to generate high quality HDR results for both static images and video as well, as shown in the picture.



Optics Antenna Effects in Semiconductor Nanostructures and Molecular Materials in Novel Photonic Devices

Professor Jon Schuller

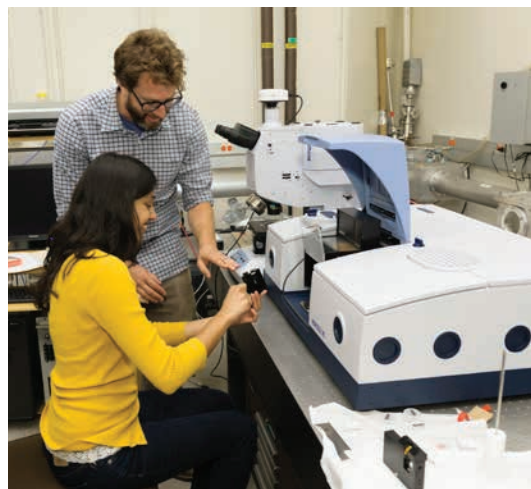

Antennas are at the heart of modern radio and microwave frequency communications. Extending antenna concepts and designs to visible and infrared frequencies may lead to new photonics technologies. ECE Assistant Professor Jon Schuller's research group investigates optical antenna effects in semiconductor nanostructures and molecular materials and exploits such phenomena in novel photonic devices.

Semiconductor Antennas

In recent years, scientists and engineers have used nanofabrication to shrink the size of metal antennas by orders of magnitude, enabling optical frequency operation. The Schuller group has shown that subwavelength semiconductor nanostructures support similar optical resonances. Semiconductor antennas exhibit a number of advantages over their metallic counterparts, particularly at infrared wavelengths. Internal dissipation can be made much lower in semiconductors, reducing unwanted heating. Furthermore, semiconductor optical properties can be tuned dynamically by changing the density of electrons. The Schuller group is leveraging these optoelectronic effects to tune the phase response of infrared frequency silicon antennas. Ultimately, they hope to design and fabricate phased arrays that are reconfigurable at GHz time scales. Such developments could lead to superior infrared beam-steering, focusing, sensing, and communications technologies.

Molecular Antennas

Organic semiconductors are certain to be used in future low-cost lighting and energy harvesting devices. In such devices, molecular constituents typically self-assemble into highly oriented structures. The Schuller group recently showed that light is emitted from organic thin-films with a radiation pattern equivalent to an assembly of oriented dipole antennas. Such optical anisotropies strongly affect the efficiency with which photons are emitted or absorbed in organic LEDs and solar cells respectively. The Schuller group is designing, fabricating, and testing new device architectures that exploit antenna effects in oriented organic semiconductors to improve coupling to outgoing or incoming photons.

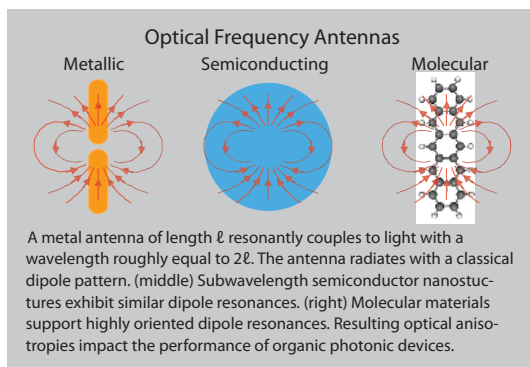

Co-Optimization of Sensing, Communications and Navigation in Mobile Sensor Networks

Professor Yasamin Mostofi



Autonomous mobile robotic networks can have a tremendous impact in many different areas such as disaster relief, emergency response, and national security. The recent disasters such as Hurricane Sandy of 2012 or Japan's earthquake of 2011 remind us of the crucial role that unmanned autonomous networks can play as part of our society. In such networks, a group of unmanned vehicles with limited local sensing, processing, communications, and actuation capabilities are given a task to perform jointly. The given resources such as energy, time or bandwidth are further very limited, while the operation environment can be harsh for sensing, communications and navigation.

Therefore, in order to realize the full potentials of a robotic network, we need a foundational understanding of the interplay between sensing, communications and navigation in these systems, which is the main motivation for the ongoing work in the lab of ECE Associate Professor Yasamin Mostofi. More specifically, Mostofi's lab is working on developing a foundational multi-disciplinary paradigm for the optimum design, task assignment and use of limited resources in robotic networks. By utilizing tools from communications, robotics/control, and signal processing, and co-optimizing the sensing, communications and navigation aspects of these problems, they have shown that considerable performance improvement can be achieved. In their proposed framework, "communication-aware motion planning", for instance, they have shown how probabilistic realistic link metrics can be co-optimized with navigation goals to reduce the overall energy consumption considerably. In another line of work, they have shown that through proper motion design and by exploiting the sparse representation of the environment, it is indeed possible for the robotic network to see through the walls and build a spatial map of occluded obstacles, using only a small number of wireless measurements.

Professor Bob York joins the list of Top 25 Revenue Producing Inventions of the UC System



Professor Bob York's Wavestream technology has made the list of Top 25 Revenue Producing Inventions of the UC System. In the mid-nineties, Professor York and his team of researchers began working on solving a very pressing technology problem for the telecomm industry: how to amplify high frequency signals for use in high-power telecomm.

Traditional techniques used wires on a circuit board to split one signal into many signals, amplify each of those, and then combine them to produce a single amplified signal. In 1996, Professor York and his grad student, Angelose

Alexander, developed an entirely new approach. Instead of using wires to split a signal, they broadcasted the signal inside a device and used numerous antennae to receive the signal then amplified it. In doing so, they eliminated the inefficiencies that had plagued the old method and made efficient, high-frequency telecomm possible.

Wavestream, a communications company, began licensing the technology from UCSB for use in their high power solid state amplifiers in 2004. The last nine years have seen Wavestream grow from a small university startup to a thriving company with a global impact and UCSB has played a major part in that growth. The technology developed at UCSB by Professor York is currently used in 90% of the amplifiers Wavestream manufactures.

Competing at the Miami Speedway A Great Ape with Energy Professor Katie Byl's Robotics Lab



Assistant Professor Katie Byl's group will be competing in the upcoming DARPA Robotics Challenge (DRC) on a team with members from UCSB, JPL, Caltech and Stanford. In the DRC, teleoperated robots will perform a variety of rescue tasks in a degraded environment. The contest is inspired by Fukushima's 2011 earthquake, in which early robot assistance at the power plant could have mitigated much of the disaster. The competition requires robots to drive cars, use tools designed for humans, and traverse rough terrain, all under teleoperation.

UCSB team members are designing control algorithms for walking, ladder climbing, and other locomotion-related tasks. Earlier this year, the team placed highly in DARPA's Virtual Robotics Challenge (VRC), designing software to control

a simulation of a humanoid. For the actual DRC, the JPL/UCSB robot has some unique characteristics. Unlike most entries, which are humanoid-inspired and also require a tether for power, the team's robot is modeled after a great ape, with equal strength and dexterity in each of its four limbs, and Robosimian is also an energetically autonomous robot, with batteries on board.

The 2013 DRC is on Dec. 18, at the Miami Speedway, and the event is open to the public. "This contest promises to push the state-of-the-art in tele-autonomous robotics, much as DARPA's earlier Challenges pushed robotics technology to pave the way for today's self-driving cars." If the team performs well this December, they will move forward and compete in the final DRC competition in Dec. 2014.

Professor Byl's Robotics Lab team qualifies as winning team in DARPA VRC



Assistant Professor Katie Byl's UCSB Robotics Lab and students Brian Satzinger, Peter Ha, and Howard Hu compete on a "Track B" team consisting of Jet Propulsion Laboratory / UCSB / Caltech. The team finished in fifth place at the cloud-based VRC competition designed to test teams' abilities to accomplish a subset of physical Challenge tasks through simulation of a robot. The VRC is a competition to develop software (no hardware) and compete in a computer stimulation between "Track B" initially funded by DARPA teams and "Track C" own expense teams. All teams were evaluated based on effective operator control of the robots in a subset of the DARPA Robotics Competition (DRC) Trials tasks, as well as addressing the areas of robot perception, manipulation, and locomotion.

Faculty Q&A

JOHN BOWERS

Professor Bowers' research interests are in energy efficiency and in the development of novel optoelectronic devices for the next generation of optical networks. These interests include silicon photonics and integrated circuits, optical switching, the design of quantum well structures for high speed light generation and detection, and the design of high speed time division multiplexed systems and devices. Prior to joining UCSB in 1987, Professor Bowers worked at AT&T Bell Laboratories on semiconductor lasers and photodetectors. Professor Bowers is Director of the Institute for Energy Efficiency and a member of the Technology Management Program (TMP).

Q: Was there something specific that drew you to UCSB?

A: I always enjoyed teaching and when I was at Stanford as a postdoc I was in charge of all the new students that came in. It was really gratifying to see them quickly learn their subject and also just learn how to do research. After at Bell Laboratories, I missed that and there were not a lot of teaching opportunities, so that's what drew me to UCSB.

Q: What are one or two of the biggest changes you have seen over the past 26 years here in the ECE Department?

A: It has really changed a lot. When I arrived we had good students coming out but no big research programs. The research program has really grown and obviously the reputation of the department has grown a lot as well.

Q: You were named Faculty Research Lecturer for 2013 which is the highest award bestowed by the University on one of its faculty. You are being recognized for your "groundbreaking scholarship, outstanding research contributions and scientific leadership." How does it feel to have received this honor?

A: It's a great honor and I'm very lucky to receive it. The research is very important to me and I've focused my life on it the past 5 or 10 years. My research focuses on trying to transform photonics from the way it's done today, which has been small foundries based on 3-5 materials, and transforming that industry towards being based on CMOS technology and silicon photonics. There are many companies and universities around the world focused on silicon photonics but our difference is that we integrate all the functions one needs particularly, including the laser.

Q: Can you tell us more about the lecture?

A: My goal is to focus on the way photonics can change people's lives and what's in the future. We've seen tremendous change over the last 20 years. The whole Internet is based on fiber optics where it used to be that communications was very expensive but that has changed with fiber optics. You can now call long-distance and it's the same as calling someone across the street. It has changed careers and it's very exciting from the point of view of the Institute for Energy Efficiency because it's far more efficient for us to load all our data on the cloud in these data centers and have them be made incredibly efficient, compared to our old desktop computers sitting in our office or home. Now, we have very efficient, low-power, handheld devices we can access

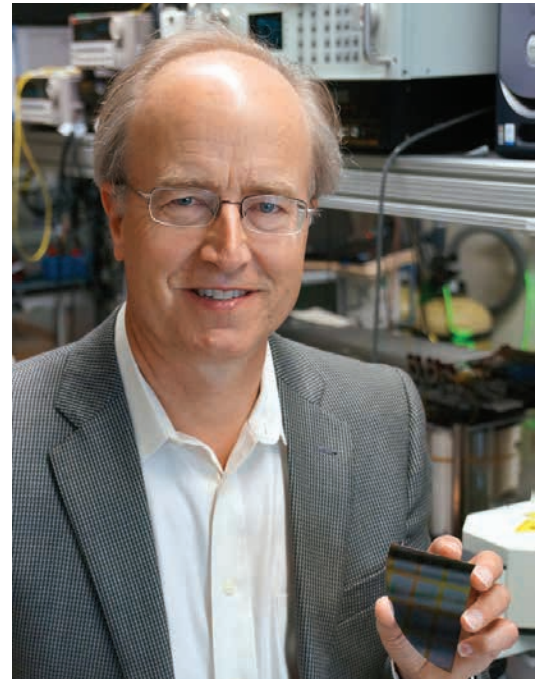



that information from everywhere and it's far more efficient. The goal of the Institute is to discover how do you make these data centers much more efficient.

Q: Can you tell us about Unite to Light?

A: Unite to Light is an outgrowth of when Osei Darkwa came from Ghana Telecom University. He wanted to learn about the Institute of Energy Efficiency, which had just formed at that point. I told him about the great LED research going on here such as solar cell research and he said to me, "why don't you do something good for the world?" I was sort of taken aback. I thought we were doing great work for the world. He said that, as a professor, he sees this big difference in the quality and success rate of students who come from Accra, the capital city where there is electricity, and other parts of the country where there isn't electricity. His goal was to get lighting for everyone so we developed a light that we can now make for about \$6. We've shipped 43,000 lights to about 60 countries around the world. There's a group in Santa Barbara called ASK, African Schools for Kenya, and they brought a bunch of the lights to the school there and were selling them and the demand was incredibly strong. We need to do a much better job at distribution because the demand and need is there.

Q: What advice would you give to students in ECE – both undergrad and graduate?

A: The main thing is to find your passion, something you really enjoy doing and that you personally find interesting and then be adaptable. Take fundamental courses here to get a broad base of understanding and that allow you to change your field of research as time goes on because what is important today is probably not going to be important 30 years from now.

Q: How do you think alumni can best give back to UCSB?

A: I think the best way is to get involved and if alumni live locally, then it's easy to get involved in mentoring. It's important for students to learn how to do quantum mechanics to learn how to do circuit design, but also, to learn the things you need to be successful in business. They should take initiative and if they see an opportunity, or a need, to go ahead and develop it and exploit it. Don't accept the world as it is today but change the world. As an engineer, you have a lot of skills and you can use those skills to make the world better, not just for those who are affluent and can afford it but also making the world socially a better place.

Q: In your opinion, what can we as a department and university do to develop our success?

A: It's important for the University to educate students in areas that the world is moving in, to communicate where the jobs are going to be and the skill set one needs to be successful in those. Too often, I think that connection is not made on freshmen when they're choosing what area to go into, but it's only when they're about to graduate that this becomes imperative. These days bioengineering is a great direction of research and energy efficiency is an important new direction for the country and our students. It's very important that we continue to evolve and not become stagnant. Do the basics, quantum mechanics in our case, and solid state physics, but also involve people in research that are in areas that industries want to hire in the future.

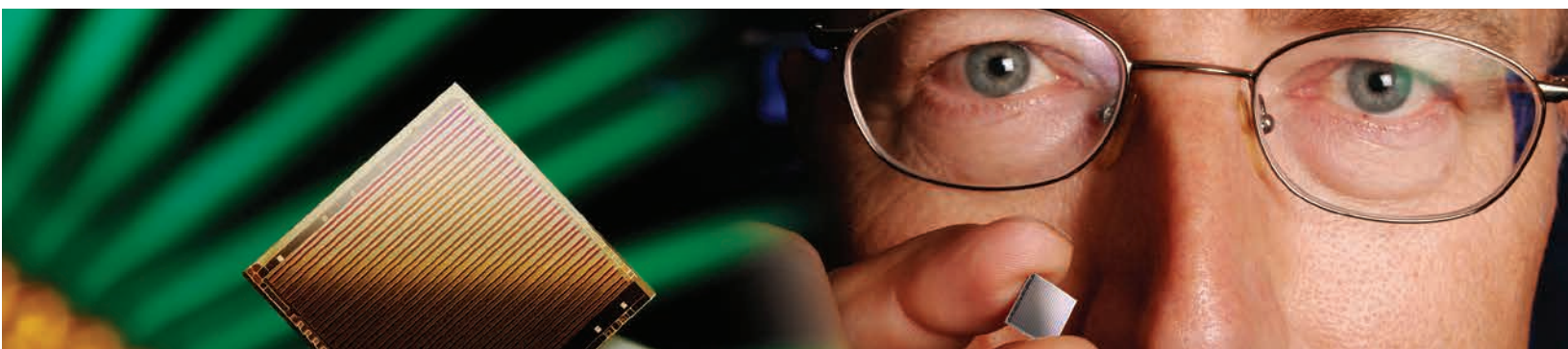

Faculty Mentorship

MAKING A DIFFERENCE



Professor Forrest Brewer

Q: As a student, did you have great faculty support?

A: I was really fortunate. I was in Physics during my time as an undergrad and got exposure to Dick Finemann at Cal Tech., which was more than inspiring, it was life changing. I learned a great deal and it greatly influenced my decision not to stick with physics. In graduate school, that had something to do with why I was more interested in doing other things such as architecture and engineering.

Q: This is sort of an open-ended question: There are always students lined up outside your door; could you tell us more about that? What keeps them coming back?

A: It's hard to say. I think it has a lot to do with my lecturing style, which some of my students have compared it to standing in front of a fire hose. I'm not so sure that's a good thing or a bad thing. For many students, I think things go a little fast and they're much happier in a personal setting to ask what's going on. The hope is that, with the way the lectures are delivered, even the people that are really sharp will see things that they should be asking about because there's more stuff behind that. I hope that they get something out of it. I do take the time to talk with them because I regard it as one of the more important things I do, it's my first job here. I love to do research but I'm not going to leave people in the cold to make that happen.

Q: Describe the work you do as faculty sponsor of the IEEE group.

A: IEEE is a student group and my job is mostly to provide an interface to the faculty for when there's an issue of some kind. One thing I have to do is to clue the people in at the end of the summer to start planning on getting people to join IEEE in the fall because new blood is the only way our organization survives. IEEE has literally grown from five to seven people to around forty due-paying members now. There's a class on microcontroller design that I run as an independent study. I also provide resources. We scrapped a bunch of computers down in the lab and I convinced people that maybe a few of those should go to IEEE because they need work stations. IEEE sees itself as a kind of learning and craft organization. It's a way of getting students together to build things and students end up learning a lot. Whether they get it from classes or whether they get it from IEEE, it's still part of the university experience, kind of a label.

Q: Describe the work that you do as a faculty adviser for undergrad students.

A: I spend a lot of time doing that. Undergrads have an even greater need for advising and you kind of owe it to them to talk about things as simple as study habits. You realize students have weaknesses but the weaknesses aren't necessarily obvious and it helps to sound them out. The fact that somebody cares, may actually surprise them. You want to make sure that they carry away from here the seeds of what will get them a little bit through life. The reality is that engineering is sort of a master level thing and leaving with a bachelor's degree is always going to leave holes. You have to select which holes you want to leave and talk to people if you want to become a professional engineer. They really need to think about grad school a little bit and what are their options are and what they can do.

Q: Do you keep in touch with any of your former students?

A: The ones that stuck out or got a PhD or advanced degrees definitely. But even a lot of undergrads will come back and talk to me or I'll see them at some place or run into them at an airport. You also have people come by asking if there's someone that does a certain kind of thing and you'll realize that maybe there's a connection you can forge with a former student so inadvertently you'll rebuild those bridges. It's kind of a nice thing actually, having students out in the real world.

Q: Do you have any general advice for ECE students?

A: I'd say one thing is that if you were away from a subject for about six months and presumably have forgotten much of what you had learned in a class, then spend a little bit of time reviewing. Not necessarily doing homework, just reviewing the high points, looking for connections about how you currently think about things. You can essentially retain twice as much. That makes your education twice as valuable and it doesn't take a huge amount of time.

In Remembrance:

On July 17, 2013, Roger C. Wood, ECE professor emeritus, passed away peacefully at his home in Santa Barbara. He will be remembered fondly for his friendly personality, his devotion to students, and his tremendous impact on setting the UC Santa Barbara College of Engineering on a projected course that would elevate it to one of the world's top-ranked engineering institutions today.

Professor Wood studied applied mathematics and was in the Air Force ROTC at the University of Minnesota, and earned his PhD in electrical engineering from UCLA. In 1965, Wood joined the faculty of UCSB's then newly formed School of Engineering – to be established as the College of Engineering the following year in 1966. During his career, he was known for research in computer system modeling, design and analysis, as well as computer architecture. He was Chair of the Electrical and Computer Engineering Department from 1971 – 1975, and became the College of Engineering's first Associate Dean for Academic Affairs in 1983.

"Dr. Roger Wood was one of the founding fathers of Engineering at UCSB," said Terri Coleman, former Assistant Dean for Student Services for the College of Engineering. "He saw the importance of establishing an independent College of Engineering, ensuring that the developed majors met the standards for accreditation, and faculty recruitment resulted in top researchers and excellent teachers."

"Roger had a great sense of humor and a story for every occasion," said Gene Lucas, UCSB Executive Vice Chancellor. "He was completely invested in education, and was one of the students' favorite professors. He gave it all to UCSB."

"Work hard, because if you work hard you will succeed and if you don't, you won't. Don't coast, don't take it easy, and most importantly, don't be afraid to ask questions."



Roger Wood, Professor Emeritus

Roger Wood Endowment

The Roger Wood Endowment was established by a group of alumni and friends from the Department of Electrical & Computer Engineering to honor and recognize Roger Wood's contributions to their lives and to the UCSB campus. Through his sustained accomplishments in research, service, teaching, and advising, Professor Roger Wood played an instrumental role in making the ECE Department the example of excellence it is today.

When he was asked about what sparked his passion for teaching and mentoring students, Professor Wood stated, "I was raised to do unto others as you would have them do unto you. Respect other people. Pay attention. Figure out what they need, what is important. One of the great rewards is seeing the light bulb go on when someone is stumbling around with something. It's extremely gratifying as a teacher to help them through something that is difficult." Through this endowment, Roger's friends pay homage to his generosity and selfless dedication to his students and colleagues. The endowment will be used to provide fellowships to exceptional undergraduate sophomore and juniors with majors in Electrical Engineering and Computer Engineering.



2013-2014 Roger Wood Endowment Recipients:

Alexander M. So
Electrical Engineering

Hsuan Chen
Computer Engineering

Recognitions



Katie Byl
Awarded the **Hellman Family Faculty Fellowship**. Fellowship awarded to promising assistant professors that show capacity for great distinction in their research.

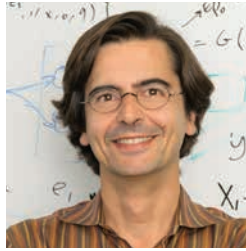

João P. Hespanha
Awarded **Keynote Speaker at the 3rd International Workshop on Wireless and Control for Unmanned Autonomous Vehicles**. WiAUV is collocated with the IEEE International Conference on Global Communications.



U Madhew (shared with Mark Rodwell)
Received the **IEEE TWC Marconi Prize Paper Award** for their paper "Indoor Millimeter Wave MIMO: Feasibility and Performance," IEEE Transactions on Wireless Communications.



Umesh Mishra
Awarded the **Heinrich Welker Award** for "sustained leadership in the development of gallium nitride-based high-power electronics from conception, education to commercialization."



Yasamin Mostofi
Received the **IEEE Region 6 Outstanding Engineer Award** designed to recognize IEEE members of Region 6 who have made outstanding contributions to their profession.

Thank you to our 2012-2013 Donors!

Adobe Systems Incorporated
Agilent Technologies Foundation
Mahfuz Ahmed, Ph.D.
Mohammad Faheem Akram '79
Mr. Robert T. Aparicio
Mr. and Mrs. Christopher D. Arcenas-Utley
Ardor Foundation
Mr. Dennis L. Balzarini, Jr.
Mr. Douglas A. Beaubien
Bitplane AG
Boeing Company
Broadcom Foundation
Mr. and Mrs. James P. Brown
Mr. Sidney L. Brown
Mr. and Mrs. Ravi K. Budhia
Dr. Peter Cappello
Cisco Systems, Inc.
Mr. Loren O. Criss
Bill R. Danielson '73, '75
Dr. Grant A. Davidson and Dr. Shihua Wang
Denso Corporation
Michael D'Errico '92
Lale and Tunç Doluca /'81
Eaton Corporation
Dr. Amr El Abbadi and Ms. Janet E. Head
Mr. and Mrs. Michael Ferris
Mr. and Mrs. Dennis M. Furuike
Patricia and David Gibson /'65, '84
Mrs. Michelle J. Glaser-Weiner
Mr. Ronald R. Gross
Toni and Thomas Guckert '79/'79
Vana Han and Kevin Robertson /'00
Ms. Susan M. Dentinger and Mr. Mark D. Hill
Mr. Douglas W. Hunt
Intel Corporation
International Foundation for Telemetry
Sara and John Jacobsen /'86
Mr. Victor N. Johnson
Mr. Vivek S. Kankanhalli

Amalia Kessler and Adam Talcott /'93, '95
Mr. Alan A. Kubitz
Mr. David G. Mana
Mr. Jerry L. Mason
Mentor Graphics
Sharyne and Gene Miller
Mr. Jonathan E. Morrissey
Mr. Harun Muliadi
Network for Good
Mr. and Mrs. Scott P. Pearsons
QLogic Corporation
Dr. William A. Radasky
Mr. Ganesh Rajan
Latha and Chulanur Ramakrishnan /'78
Raytheon
Vana Han and Kevin Robertson /'00
Dr. and Mrs. Michael D. Santos
Mr. and Mrs. Naftali Sauerbrun
Linda and Jeffrey Schlageter '65/'65, '67
Mr. Richard W. Scott
Mr. and Mrs. Pradip Shankar
Mr. Allen Shum
Ms. Vinita Singhal
Springsoft USA
SRC Education Alliance
Mr. Bill Stevens
Marianne and Thomas Stockton /'65, '67
Mr. David R. Styerwalt
Systems Engineering International
Amalia Kessler and Adam Talcott /'93, '95
Mr. Tuan A. To
Mr. and Mrs. David B. Vandervoet
Mr. John J. Walters, Jr.
Mr. Joseph D. Webster
Mr. Aaron Weiner
Edwin Wrench, Jr. '69
Hua Yang '05
Mr. and Mrs. James C. Yu
Mr. Hsing B. Yuan and Ms. Jane J. Hsu



Behrooz Parhami
Awarded **IEEE Life Fellow**, a distinction reserved for select members whose extraordinary accomplishments are deemed fitting of this prestigious grade elevation.

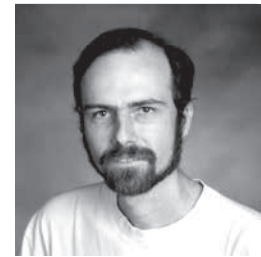

Ken Rose
Awarded the **IEEE International Conference on Multimedia and Expo (ICME) Best Paper** for the paper, co-authored with his students, "A Unified Estimation-Theoretic Framework for Error-Resilient Scalable Video Coding."



Jon Schuller
Received the **Regents Junior Faculty Fellowship Award** for his research project entitled "Infrared Plasmonics."

National Academy of Engineering members:

Rod Alferness (2003)
John Bowers (2005)
Steve Denbaars (2012)
Nikil Jayant (1996)
Herbert Kroemer (1997)
Sanjit Mitra (2003)

David Auston (1989)
Larry Coldren (2004)
Arthur Gossard (1987)
Petar Kokotovic (1996)
Umesh Mishra (2009)
Lawrence Rabiner (1983)

Invest in the Department of Electrical and Computer Engineering

The goal of the Department of Electrical and Computer Engineering at UC Santa Barbara has always been to provide our students with the best possible opportunities to learn and develop. The faculty, students, and administration have created an atmosphere of interdisciplinary and collaborative research that is renowned throughout the Nation and is the cornerstone of our success.

Your investment in the Department of Electrical and Computer Engineering plays a critical role in our ability to fulfill our mission and provides essential support of ECE's teaching program and research enterprise.

Department funding opportunities include:

-**Unrestricted support** to be allocated to the highest priority needs of the Department.

-**Roger Wood Endowment**, established in honor of esteemed faculty member Roger C. Wood, supports undergraduate and graduate fellowships, faculty, and state-of-the-art teaching facilities.

-**Undergraduate laboratory** renovations to maintain and upgrade the quality of essential facilities for teaching and research. Priority renovations and naming opportunities include: Digital Lab, Controls Lab, Computer Engineering Lab, High Speed Communications Lab, Microwave Lab, Digital Signal Processing Lab, and the Instructional Clean Room.

-**Endowed chair establishment**, which honors, encourages, and supports the professors whose brilliant minds and commitment to education and research promote the University's mission.

Current Endowed Chairholders include:

John Bowers,

Fred Kavli Chair
in Nanotechnology



Mark Rodwell,

Doluca Family Chair
in Electrical and
Computer Engineering



Umesh Mishra,

Donald W. Whittier
Chair in Electrical
Engineering



Larry Coldren,

Fred Kavli Professor
of Optoelectronics
and Sensors



Please use the donation form below and enclosed envelope to make your annual gift to the Department of Electrical and Computer Engineering.

For more information about how you can support the Department, please contact Melinda Glasgow Douglas at 805-893-2580 or melinda.glasgow@ia.ucsb.edu.

To give to ECE online, visit <https://www.giveucsb.com/ece.htm>

YES! I WANT TO SUPPORT ECE!

Name _____ Former Name (if any) _____

Address _____ City _____ State _____ Zip _____

E-mail address _____ Degree _____ Field _____

Please include a **business card** in the return envelope provided so we can update our records!

GIFT DESIGNATION

Please direct my gift where the need is greatest in ECE
at the discretion of the Department Chair

Roger Wood Endowment

Please use my gift for the following: _____

Enclosed is my gift of:

\$1,000 - \$9,999 Chancellor's Council

\$500 - \$4,999 Young Alumni Chancellor's Council (Alumni since 2003)

\$500 \$250 \$100 Other _____

Matching Gift Employer: _____

Matching Gift Form is enclosed: Yes No

PAYMENT METHOD

I have enclosed a check payable to **UC Santa Barbara Foundation**.

Please charge \$ _____ now to my credit card.

VISA Master Card American Express Discover

Name (as it appears on card): _____

Account Number: _____

Exp. Date _____ Signature: _____

PLEASE TELL ME HOW I CAN

Make a gift using securities

Enjoy the benefits of estate planning

THANK YOU FOR YOUR GENEROUS GIFT!

Appeal Code: 13ECE

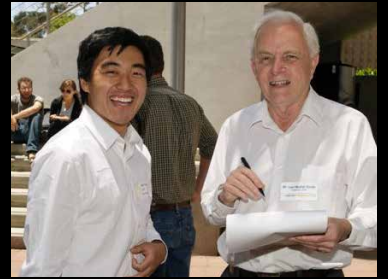

ece.ucsb.edu

Department of Electrical and Computer Engineering,
UC Santa Barbara, Santa Barbara, CA 93106-9560

